

Class B AIS Transponder with Wide Angle Colour TFT LCD



Benefits of AIS (Automatic Identification System)

An AIS transponder on your boat automatically receives information broadcast by other AIS-equipped vessel's and base stations, all while your own vessel's static and dynamic information is being transmitted. Using with an AIS transponder, you can find AIS mounted small boats and buoys that are difficult to be detected with a marine radar. The MA-510TR can receive both Class A and B AIS signals and increases your safety at sea.



Risk Management and Simplified Navigation

4.3-inch Colour TFT LCD

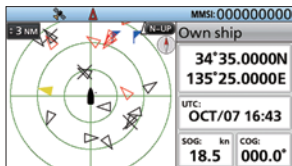

Plotter screen (Day mode)

The wide viewing, high resolution 4.3-inch colour TFT display clearly shows your and other vessels' positions. Potentially dangerous vessels are shown in red and ships registered as your friends are shown in yellow.

The day-mode display is readable in direct sunlight, and the night-mode display ensures good readability in the dark for further convenience.

AIS Target List and Details

TARGET LIST (6)		
MMSI/Name	RNG	BRG
▲SAMPLE1	0.4	309.5
▲SAMPLE2	1.2	283.4
▲SAMPLE3	2.0	277.9
▲SAMPLE4	2.8	275.6
▲SAMPLE5	3.6	274.4

Target list screen

<p>DETAILS 1/6</p> <p>Class A MMSI: 000000000 SAMPLE Call sign: ICOM IMO Number: ----</p>	<p>DETAILS 2/6</p> <p>CPA: 1.5 NM TCPA: -2 min LAT: 34°34.0480N LON: 135°26.8540E SOG: 0.9 kn COG: 188.8°</p>	<p>DETAILS 3/6</p> <p>HDG: 228° PA: Low Range: 1.8 NM Bearing: 122.1° ROT: 5.708°(+) / min</p>
<p>DETAILS 4/6</p> <p>Length: 23 m Beam: 12 m Draft: 4.5 m</p>	<p>DETAILS 5/6</p> <p>Type of ship: 70 Cargo - All ships of this type Nav status: Under way using engine Destination: >JP SBK</p>	<p>DETAILS 6/6</p> <p>Estimated time of arrival: OCT/06 10:30 Elapsed: 0 min</p>

Detail screen examples

The 'Target' list screen shows all detected AIS equipped vessels and targets. The 'Danger' list screen shows a list of vessels that are within six nautical miles of Closest Point of Approach (CPA) and sixty minutes of Time to Closest Point of Approach (TCPA) from your vessel. The 'Friend' list screen displays the detected AIS targets that you set as friends. When you want to see target details, select the target by the cursor keys and push [ENT] key.

Simplified Navigation Function

The Navigation function guides you to a specified waypoint or AIS target. You can assign a maximum of 100 favourite fishing spots or destinations as waypoints. The Navigation function is simply started by just selecting a waypoint or an AIS target on the display.

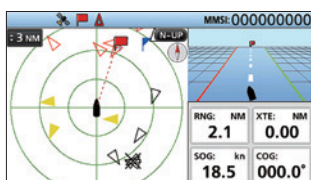

Plotter screen with Navigation screen

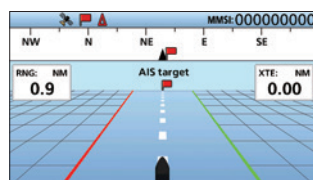

Navigation screen

Navigation to MOB Waypoint

When the [WPT/MOB] button is held down, the MA-510TR automatically marks a waypoint of the vessel's current position and activates the MOB (Man Overboard) navigation function to the location the MOB event occurred.

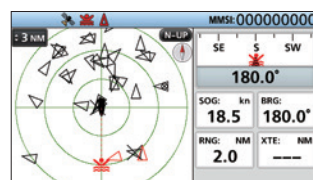

Plotter screen with MOB Navigation screen

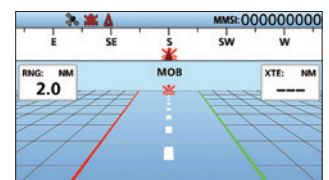

MOB Navigation screen



Night mode screen

in One Package

Individual DSC Call

You can transmit an individual DSC Call by simply selecting an AIS target and the voice channel on the MA-510TR*.

* A compatible Icom VHF radio is required. The MA-510TR and a radio can be connected with the accessory cable. See the instruction manual of each for radio's connecting instructions.

USB Connectivity

AIS data can be output from an USB cable connector on the rear panel*.

* A third party application and a connection cable are required.

Supplied GPS Antenna



Supplied GPS antenna

The GPS receiver with SBAS function is integrated in the MA-510TR. Position information can be simply received with connection to the supplied GPS antenna with 10 m, 32.8 ft cable.

NMEA 2000™ & NMEA 0183 Connectivity

With the plug-and-play functionality of NMEA 2000™, the MA-510TR can connect to a NMEA 2000™ network (an external plotter, marine radar and VHF radio). Using NMEA 0183/-HS connectivity, the transponder can connect to a transceiver, plotter device, marine radar or GPS receiver.

Collision Alarm Function

When a vessel comes into the CPA or TCPA range, the vessel's icon blinks on the plotter display and a beep sound is heard. When connected to external audio equipment installed on the chart table or fly bridge, the collision alarm function will alert you, even when you are away from the AIS transponder.

Silent Mode for Security and Privacy

Silent mode switches off the AIS transmitter and allows you to temporarily stop transmitting your vessel's position information. This function is useful when you do not want to reveal your fishing spots to other vessels. You can receive other vessel's AIS reports also while the silent mode is ON.

Other Features

- Compatible with both 12 V and 24 V power sources
- Multi-lingual user interface (English, French, Indonesian, Spanish and Vietnamese)
- Anchor watch function sounds an alarm when your vessel is at anchor but has drifted
- IPX7 waterproof protection (up to 1 m depth of water for 30 minutes; except connectors)

SPECIFICATIONS

GENERAL	
Frequency coverage	161.500 MHz to 162.025 MHz
Type of emission	16K0GXW (GMSK)
Antenna impedance	50 Ω nominal
Intermediate frequency	CH-A 1st: 21.700 MHz, 2nd: 450 kHz CH-B 1st: 30.150 MHz, 2nd: 450 kHz
Operating temperature range	-20°C to +60°C, -4°F to +140°F
Power supply requirement	Negative ground: 12 V or 24 V DC nominal (9.6 to 31.2 V)
Current drain (at 12 V DC)	TX: 1.5 A, RX: 0.7 A
Dimensions (approximate)	166.2 (W) × 110.2 (H) × 92.5 (D) mm, (Projections not included) 6.5 (W) × 4.3 (H) × 3.6 (D) inch
Weight (approximate)	700 g, 1.5 lb

TRANSMITTER	
Output power	2 W
Modulation	16K0GXW (GMSK)
Conducted spurious emission	Less than -36 dBm (9 kHz-1 GHz) Less than -30 dBm (1 GHz-4 GHz)

RECEIVER (AIS)	
Sensitivity	Less than -110 dBm
Adjacent channel selectivity	More than -31 dBm
Spurious response	More than -31 dBm
Intermodulation	More than -36 dBm
Conducted spurious emission	Less than -57 dBm (9 kHz-1 GHz) Less than -47 dBm (1 GHz-4 GHz)
Blocking	More than -15 dBm (±0.5 MHz-±5 MHz) More than -23 dBm (±5 MHz-±10 MHz)
Co-channel	More than -111 dBm

RECEIVER (DSC)	
Frequency coverage	156.525 MHz
Type of emission	16K0G2B
Sensitivity	Less than -110 dBm
Adjacent channel selectivity	More than 70 dB
Spurious response	More than -34 dBm
Intermodulation	More than -39 dBm
Blocking	More than -20 dBm

GPS ANTENNA	
Received frequency	1575.42 MHz
Acquisition	72 ch (maximum)
Differential satellites	WAAS, EGNOS, MSAS, GAGAN
Dimensions (approximate)	96.2 × 225 (H) mm, 3.8 × 8.9 (H) inch
Weight (approximate)	700 g, 1.5 lb (including cable and mounting bracket)
Cable length (approximate)	10 m, 32.8 ft

DATA INTERFACE		
USB (Type-B Mini)	GGA, GNS, GLL, GSA, GSV, RMC, VTG, VDM, VDO, ACA, ACS, ALR, TXT	
NMEA 2000™	Input	059392/904, 060160/416/928, 065240, 126208/996, 129026/029/545
	Output	059392/904, 060416/928, 126208/464/993/996/998, 129026/029/038/039/040/041/539/540/545/792/793/794/797/798/801/802/803/805/806/807/809/810/811
NMEA 0183	NMEA Input/Output	4800-38400 bps Input/Output, sentence format (Output: GGA, GNS, GLL, GSA*, GSV*, RMC, VTG, GBS, DTM, DSC)
	External GPS Input	4800-38400 bps Input, sentence format (GGA, GNS, GLL, RMC, VTG, GBS*, DTM)
	AIS Output	38400 bps Output, sentence format (VDM, VDO, ACA, ACS, ALR, TXT)

*1 Only 38400 bps. *2 When a received GPS signal does not include a GBS sentence, the transponder will not receive the signal from the external GPS receiver.

All stated specifications are subject to change without notice or obligation.

Icom, Icom Inc. and the Icom logo are registered trademarks of Icom Incorporated (Japan) in Japan, the United States, the United Kingdom, Germany, France, Spain, Russia, Australia, New Zealand and/or other countries. NMEA 2000 is a trademark of the National Maritime Electronics Association, Inc. All other trademarks are the properties of their respective holders.

OPTIONS

MB-75 FLUSH MOUNT KIT



For flush-mounting the MA-510TR to a flat surface, such as a control panel.

MB-132 FLUSH MOUNT KIT



For flush-mounting the MA-510TR to a flat surface, such as a control panel.

CS-MA510TR PROGRAMMING SOFTWARE

REAR PANEL VIEW

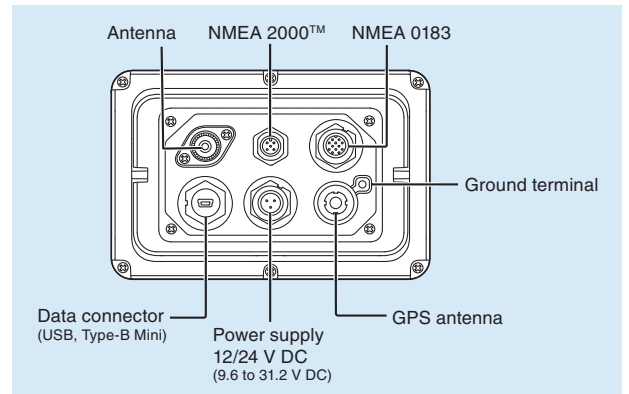

DIMENSIONS

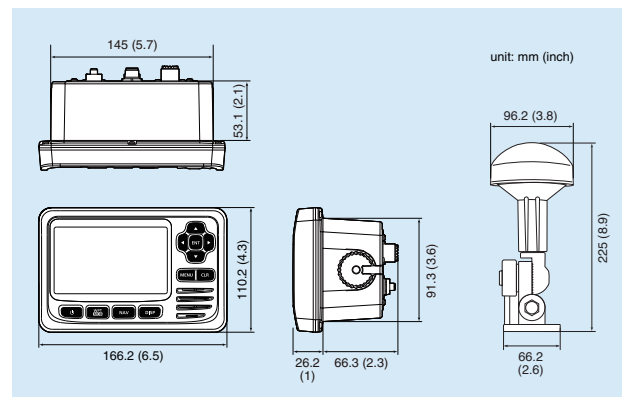

- Supplied Accessories:**
- GPS antenna
 - DC power cable
 - Mounting bracket kit
 - Accessory connector

Compatible Icom VHF Radios* with the MA-510TR:
 IC-M605, IC-M605EURO, IC-M506, IC-M506EURO, IC-M506GE, IC-M424, IC-M424G, IC-M423, IC-M423G, IC-M423GE, IC-M400BB, IC-M400BBE, IC-M330, IC-M330G, IC-M330GE, IC-M324, IC-M324G, IC-M323, IC-M323G
 * As of May 2020

Icom Inc. 1-1-32, Kamiminami, Hirano-Ku, Osaka 547-0003, Japan Phone: +81 (06) 6793 5302 Fax: +81 (06) 6793 0013 www.icomjapan.com **Count on us!**

Icom America Inc.
www.icomamerica.com

Icom (Europe) GmbH
www.icomeurope.com

Icom (Australia) Pty. Ltd.
www.icom.net.au

Your local distributor/dealer:

Icom Canada
www.icomcanada.com

Icom Spain S.L.
www.icomspain.com

Icom Brazil
E-mail: sales@icombrasil.com

Icom (UK) Ltd.
www.icomuk.co.uk

Icom France s.a.s.
www.icom-france.com