

 ICOM

HF/50MHz TRANSCEIVER

IC-7760

A New Innovative Shack Style Full Control Head with Separated RF Deck



High Power & Clean Transmit Signal for

A New Innovative Shack Style

In today's connected world, the IC-7760 introduces a new connected system consisting of a control head and RF deck, connected with a commercially available control (LAN) cable. This concept increases the flexibility of your station installation, making more space available on the desktop by placing the RF deck in an area closer to the antenna feed point. In addition to the direct connect feature, control head to RF deck, utilize your home network to make any tabletop your shack and a PC is not required!



Great Strength in Contests and DX Hunting

Feature 01

Full Control Head with Separated RF Deck

The IC-7760 consists of a separate control head and RF deck and uses a control cable for connecting between them. It increases the flexibility of the installation. A control cable (3 m, 9.8 ft) is supplied with the radio, and a commercially available LAN cable* can be used to install the RF deck in a more remote location. It enables the RF deck to be placed in a rack or other location away from the station desktop, providing a quiet shack environment away from the noise of the fan used to dissipate the heat generated by the RF deck.

* LAN cable: Cat5e or higher.
Cable length: Maximum 100 m, 328 ft

Feature 02

Supports In-house Remote Operation Through a Home LAN Connection

The IC-7760 can be connected to the control head and RF deck through a wired home LAN network*. This gives the user even greater flexibility of the RF deck. Because of its simple configuration that does not require a PC, the control head of the IC-7760 can be moved anywhere in the house and operated not only from the shack but also from the living room, etc., as long as a LAN connection is available.

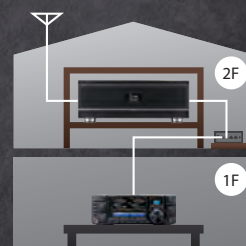

In-house Remote Operation

* Communication between the control head and the RF deck depends on the network environment in which it is used. Gigabit Ethernet is required. The control head can be used on a different network segment than the RF deck such as over a network switch.



Dual, Independent Receivers

The IC-7760 has independent MAIN/SUB receivers, from the antenna to the speaker, so that one receiver section has no effect on the other, providing simultaneous reception of two signals in different bands/modes with identical performance. As with the IC-7851, dual spectrum scopes provide simultaneous display of the MAIN and SUB bands allowing the operator to see the changing band conditions.

Receiver Block Diagram

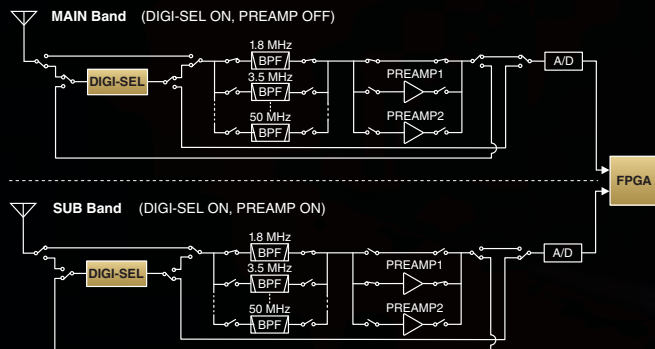

Advanced RF Direct Sampling System

The IC-7760 adopts the RF direct sampling system, in which RF signals are directly converted to digital signals and the signals are processed by an FPGA (Field Programmable Gate Array). This system avoids non-linear distortions that occur in mixer stages during the analog signal processing. In addition, by employing DSP units in both the RF deck and control head, the IC-7760 is able to handle complex audio path switching due to various interface inputs and outputs, while minimizing delay in a home LAN environment.



DSP + FPGA Unit (RF Deck)



DSP Unit (Control Head)

Block Diagram Overview

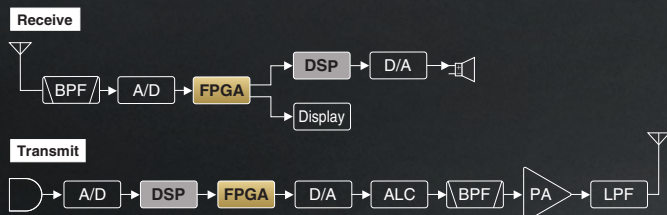

DIGI-SEL and Preamp

The DIGI-SEL (Digital Pre-selector) is highly effective in rejecting out-of-band strong signals such as from broadcasting stations or multi-multi operation. In conventional models (such as IC-7850/51 or IC-7610), the DIGI-SEL circuit was located soon after the RF input (antenna) to prevent signal distortion by out-of-band interference. Even if the preamp was turned ON, the noise figure (receiver sensitivity) could not be improved, as DIGI-SEL had an insertion loss due to its narrow bandwidth. In the IC-7760, which is a direct sampling system, DIGI-SEL prevents overflow (OVF) due to unwanted out-of-band signals rather than signal distortion, and the preamp uses the A/D converter to take full advantage of its dynamic range. When preamp is turned ON in the IC-7760, the preamp enhances the intended signal first, then DIGI-SEL filters out unwanted

out-of-band signals. This makes it possible that the preamp works together with DIGI-SEL.

	IMD	Sensitivity	Overflow
PREAMP ON	★★ (Fine)	★★★ (Superb)	— (Decent)
DIGI-SEL ON	★★★★ (Superb)	★★ (Fine)	★★★★ (Superb)
PREAMP ON DIGI-SEL ON	★★ (Fine)	★★★ (Superb)	★★★★ (Superb)

Block Diagram Overview

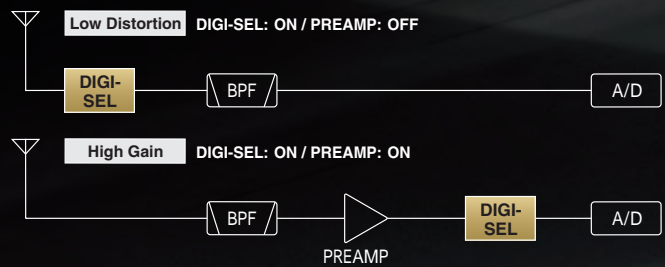

A Total of 15-separated BPF

While the previous model covered HF bands with a 9-separated BPF (Band Pass Filter), the IC-7760 uses an 11-separated BPF in HF bands. In addition, by employing sharp filters specialized for each amateur band, the BPF efficiently attenuates out-of-band interference signals in the RF stage, and prevents overflow at the A/D converter.

BPF Characteristics <IC-7760>

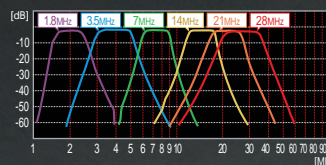

BPF Characteristics <IC-7610>

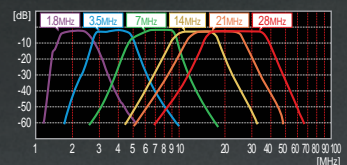

Showing primary BPF for HF amateur bands

HF/50 MHz TRANSCEIVER

IC-7760



DPD (Digital Pre-Distortion) Technology

The DPD function corrects non-linear distortion at the final amplifier by applying inverse distortion in advance. A clean signal transmission is achieved while providing 200 W of high output power at the same time. The DPD function also works at the 1 kW output in combination with the IC-PW2*.

* DPD feedback cable OPC-2501 is required when using with the IC-PW2.



DPD OFF (Signal Received on the IC-7300) DPD ON (Signal Received on the IC-7300)
No spurious emission observed

100% Duty Cycle at 200 W Output

The IC-7760 uses a 450 W-class 65 V LDMOS-FET in the PA section, combined with a large heatsink and effective cooling system to achieve a generous 200 W full power full duty operation*. Continuous FT8 mode operation is also possible. Furthermore, modulation and frequency conversion are made through digital signal processing, the D/A converter directly outputs the transmit frequency, achieving the purest transmission C/N.

* 200 W and 1 hour continuous transmission with 100 V AC input (at ambient temperature 25°C.)



PA Unit with a Large Heatsink

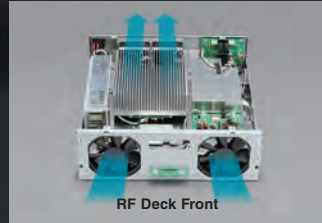

Effective Cooling System with Four Fans

Built-in Automatic Antenna Tuner

The IC-7760 incorporates a mechanical relay type internal antenna tuner as a first for our 200 W models. It provides faster tuning than the conventional variable capacitor type. Once tuned, the matching information is automatically recalled the next time the frequency is selected, facilitating smooth band changes and multi-band operation.



Antenna Tuner Unit

Dual Display Control Head

The IC-7760 control head has main and sub dual displays. The displays are one 7-inch-wide main display (800 × 480 pixels, WVGA) and one 2.4-inch sub display (320 × 240 pixels) and both displays are touch screens. The main display shows information necessary for operation, including MAIN/SUB operating frequencies, and setting/operating status of each function.

The 2.4-inch, sub-display, can show the filter effect, various meters, and a band stacking register. The filter effect screen can display the IF filter passband width and IF filter shape superimposed on the IF filter passband signal. This function shows you visible images of twin PBTs, manual notch effects. The improved visibility of information enhances operability and ensures smoother operation.

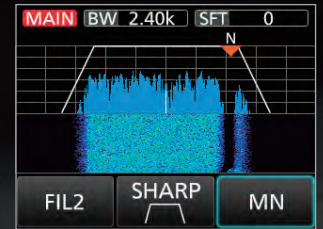

Filter Effect Example

1.8	3.5	7
10	14	18
21	24	28
50	GENE	F-INP

Band Stacking Register

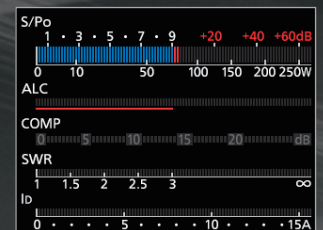

Various Meters Example
(S/Power, ALC, COMP, SWR, Id)

Dual Spectrum Scope and Waterfall

The dual Spectrum Scope provides excellent sweep speed, resolution, and a wide dynamic range of 100 dB with FPGA, DSP and CPU combined processing for main and sub bands. It can also monitor two different bands at the same time, which is useful for monitoring conditions and during contests. In the Continuous SCROLL mode, a wide bandwidth exceeding 1 MHz can be seen on the scope screen. The waterfall display shows changes in the frequency spectrum vertically, enabling the user to find a weak signal that is difficult to detect with the spectrum scope. Increases QSO possibilities without missing weak DX stations.



Top-to-bottom Dual Scope Example



Left-to-right Dual Scope Example





Feature 06

Dual Speakers

The IC-7760 is also equipped with dual speakers. By separating the MAIN/SUB audio into left and right speakers, respectively, distinguishing the audio during Dualwatch operation is improved. MAIN/SUB audio can be set for stereo or mono output from both speakers.



MAIN/SUB Dual Speakers

PRESET FT8 Menu

Introduced with the IC-7300 as FT8 is actively used around the world in everyday operation as well as with DXpeditions. FT8 can be easily set up by simply selecting it from the [Preset] memory and all necessary items can be set at once. Moreover, when returning to the normal settings from FT8, simply select [Normal] memory for a smooth transition. In addition, up to 3 [Preset] memories can be written to preset SSTV as well as future new digital modes to be supported.



FT8 Mode Preset

Automatic Contest Serial Numbering

This function is powerful in CW and RTTY contests. Each time the pre-programmed memory is transmitted, the serial number is automatically counted from 001. The serial number can be set in multiple locations to ensure that the contest number is reliably copied.



Contest Serial Numbering Example

Audio Scope Flexibility

The Audio Scope screen shows the transmit and received signal's frequency components on the FFT scope, and its waveform components on the Oscilloscope. The Audio Scope makes it easy to monitor signal characteristics such as microphone compressor level, filter width, and notch filter. You can monitor received CW keying wave forms in the Oscilloscope.

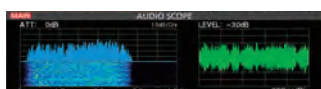

Audio Scope Example

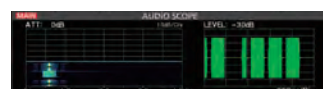

CW Keying Form Example

RC-28 for a Second VFO Knob

By connecting the optional RC-28 via USB connection, the SUB band tuning of the IC-7760 can be conveniently operated with your fingertips. MAIN/SUB switching buttons can be assigned to the F-1 and F-2 buttons on the RC-28 and it can operate as the main dial for both MAIN and SUB bands.



Use Image of the Optional RC-28

SD Card Slot

An SD card slot is provided as an interface for data storage. In addition to voice recordings of outgoing and incoming calls, RTTY/PSK decode logs, captured images of the display, user settings, and firmware updates can be saved in the storage. Voice memories sent in Phone modes, and message memories sent in CW/RTTY/PSK modes, can also be stored. In addition, when an operator is replaced, the operator can simply load their preferred settings from the storage to immediately start operating.



SD Card Slot

Touch Screen and Multi-Dial Knob

The combination of the touch screen and the multi-dial knob offers easy access to various settings. When the multi-dial knob is pressed, menu items appear on the right side of the display near the dial. Touch that menu to select an item, then turn the multi-dial knob to adjust the level, providing much faster access to various functions such as RF power, microphone gain, DIGI-SEL, and notch functions.

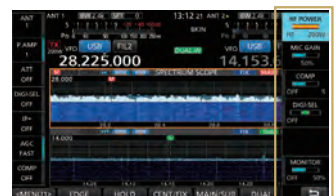

Multi-Function Menu

RS-BA1 – Internal Server

Whether from a remote part of your home QTH, or at a remote location somewhere around the world, the RS-BA1 Version 2 software enables you to operate your IC-7760.

The Dualwatch operation and dual spectrum scopes with the waterfall functions can be used on your remote PC. With the addition of an Ethernet connector, a base station computer is not required.

I/Q Signal Output

I/Q signals received by the IC-7760 can be output from a dedicated I/Q signal connector (USB on the RF deck) to a PC for digital output. Using the I/Q signals on the HSDR*, you can listen to received signals, or display the spectrum scope on the PC. Used in combination with the CW Skimmer* or N1MM Logger+*, you can virtually decode all Morse signals in the operating band. This function is particularly useful for contesting and DX hunting, and effective callback during split operation.



USB Connector on the RF Deck (USB 3.0 cable required)

* USB I/Q driver package can be downloaded from the Icom web site. HSDR, CW Skimmer and N1MM Logger+ software are not supplied from Icom.

External Display Connection

The IC-7760 has an external display connector (DVI-D) on the control head to output digital signals of the main display to an external display without signal degradation. The main display can be mirrored on a large external display.



External Display

Other Outstanding Features

RX Antenna

- BNC type RX IN/OUT connectors for a receiver antenna or external BPF/preamp connection

CW Mode

- FPGA-controlled CW keying waveform shaping
- Multi-function electronic keyer
- CW pitch control from 300 Hz ~ 900 Hz (5 Hz step)
- Auto repeat function
- Normal or short Morse number style
- Double key jack system
- Full break-in and semi break-in
- CW auto tuning
- APF (Audio Peak Filter) function adjustable filter shape, width, and AF level
- 136 kHz band operation (EUR version only)

Receiver

- 30 kHz ~ 60 MHz receiver (Some frequencies are not guaranteed.)
- Two types of preamps
 - Preamp 1: Wide dynamic range preamp
 - Preamp 2: High gain preamp

- 3 dB ~ 45 dB variable attenuator (3 dB step)
- IP+ function improves 3rd order intercept point performance
- Main/Sub band tracking function for diversity reception
- Twin peak audio filter for the RTTY mode
- RTTY/PSK encoder and decoder
- Adjustable AGC time constant from 0.1 to 6 seconds (FM mode is fixed)

Transmitter

- TX monitor function
- All mode power control
- VOX (Voice Operated Transmission) capability
- BNC type transverter connector
- Microphone equalizer
- Adjustable transmit bandwidth
- 50 CTCSS tones
- Transmit Power Limit function for each band

Operation

- Memo pad stores up to 10 operating frequencies and modes
- Quick split function

- Quick Dualwatch function
- RF gain and squelch control with a knob
- RIT and Δ TX variable up to 9.999 kHz
- UTC/local clock and timer function
- 1 Hz pitch tuning and display
- Dial lock and panel lock functions
- Adjustable main dial brake
- External speaker jacks for Main and Sub receivers
- Screen saver function
- Multi-function meter (S-meter, Power, ALC, COMP, SWR, Id, Vd and TEMP)
- Auto tuning step function
- AH-730 external antenna tuner control (When the AH-730 is connected, output power of the specified antenna terminal is automatically set to 100 W or less)
- MAIN/SUB AF mute
- Adjustable LCD/LED backlight
- USB port for optional RC-28, keyboard, mouse and USB flash drive connection

Rear Panel View

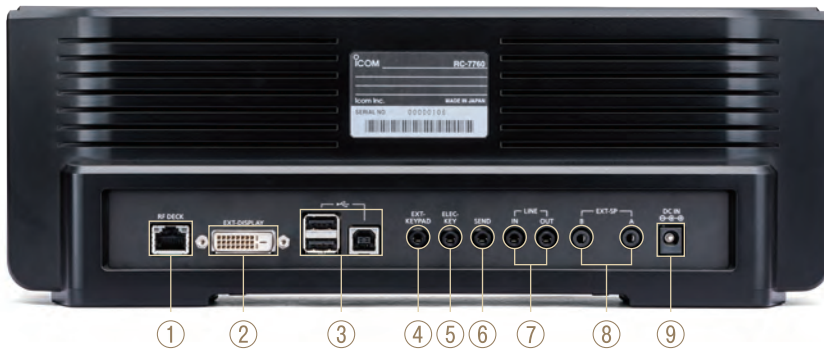

Control Head

- | | |
|--------------------------------------|--------------------------|
| ① RF Deck Connector | ⑥ SEND Control Jack |
| ② External Display Connector (DVI-D) | ⑦ LINE IN/OUT Jacks |
| ③ USB Connectors | ⑧ External Speaker Jacks |
| ④ External Keypad Jack | ⑨ DC IN Jack |
| ⑤ Electronic Keyer Jack | |



RF Deck

- ① Antenna Connectors
- ② Transverter Connector (BNC)
- ③ RX Antenna IN/OUT Connectors (BNC)
- ④ Reference Frequency Input (10 MHz)
- ⑤ Tuner Control Socket
- ⑥ Control Head Connector
- ⑦ LAN (Ethernet) Connector
- ⑧ CI-V Remote Control Jack
- ⑨ Key Jack
- ⑩ ALC Input Jack
- ⑪ SEND Control Jack
- ⑫ Accessory Sockets
- ⑬ USB Connector (I/Q OUT)
- ⑭ Ground Terminal
- ⑮ AC Power Socket
- ⑯ Main Power Switch

SPECIFICATIONS

GENERAL		
Frequency coverage	Receiver*1	0.030 ~ 60.000 MHz*2
	Transmitter*1	0.1357 ~ 0.1378, 1.810 ~ 1.999, 3.500 ~ 3.800, 7.000 ~ 7.200, 10.100 ~ 10.150, 14.000 ~ 14.350, 18.068 ~ 18.168, 21.000 ~ 21.450, 24.890 ~ 24.990, 28.000 ~ 29.700, 50.000 ~ 52.000 MHz
*1 EUR version. Varies according to version. *2 Guaranteed range: 0.100 ~ 29.999, 50.000 ~ 54.000 MHz.		
Mode	USB, LSB, CW, RTTY, PSK31/63, AM, FM	
Number of channels	101 (99 regular, 2 scan edges)	
Antenna connectors	SO-239 x 4 (50 Ω unbalanced, Tuner off) BNC x 1 (RX antenna In/Out)	
Power supply requirement	RF deck 90 ~ 264 V AC Control head 15.0 V DC ±0.75 V (with BC-267A/E)	
Power consumption	Tx (High)	800 VA
	Rx	RF deck + control head 150 VA typ. (Stand-by/Max. audio) Control head 3.0 A (Max. audio at 15.0 V DC)
Operating temperature range	0 °C ~ +50 °C; 32 °F ~ 122 °F	
Frequency stability	Less than ±0.5 ppm (0°C ~ +50°C; 32°F ~ 122°F)	
Frequency resolution	1 Hz (minimum)	
Dimensions (W x H x D) (projections not included)	RF deck 425 x 149 x 442 mm; 16.7 x 5.9 x 17.4 in Control head 340 x 118 x 103.5 mm; 13.4 x 4.6 x 4.1 in	
Weight (approximately)	RF deck 15.8 kg; 34.8 lb, Control head 2.3 kg; 5.1 lb	
TRANSMITTER		
Output power (HF/50 MHz)	SSB/CW/FM	1 ~ 200 W
	AM	0.25 ~ 50 W
	Transverter	More than -20 dBm (137 kHz, HF/50 MHz)
Modulation system	SSB	Digital P.S.N. modulation
	AM	Digital Low power modulation
	FM	Digital Reactance modulation
Spurious emissions	Unwanted emission	HF bands: Less than -50 dB, 50 MHz: Less than -66 dB
	Out of band emission	HF bands: Less than -40 dB, 50 MHz: Less than -60 dB
Carrier suppression	More than 50 dB	
Unwanted sideband	More than 50 dB	
Microphone impedance	600 Ω	





RECEIVER				
Receiver system	Direct Sampling Superheterodyne			
Intermediate frequency	12 kHz			
Sensitivity*3 (Filter shape: Soft)	135 kHz band	0.5 ~ 1.799 MHz	1.8 ~ 29.999 MHz	50 MHz band
	SSB/CW (at 10 dB S/N, BW = 2.4 kHz)	1.41 μV typ.	—	0.16 μV typ. 0.13 μV typ.
	AM (at 10 dB S/N, BW = 6 kHz)	—	6.3 μV typ.	2.0 μV typ. 1.0 μV typ.
	FM (at 12 dB SINAD, BW = 15 kHz)	—	—	0.5 μV typ.*4 0.32 μV typ.
*3 HF: Preamp 1 ON, 50 MHz: Preamp 2 ON *4 28.0 ~ 29.7 MHz only				
Sensitivity for RED*5 (Filter shape: Soft)	1.8 ~ 2.999 MHz	3.0 ~ 29.999 MHz	28.0 ~ 29.7 MHz	50 MHz band
	SSB (at 12 dB SINAD)	10 dBμV emf	0 dBμV emf	— -6 dBμV emf
	AM (at 12 dB SINAD)	16 dBμV emf	6 dBμV emf	— 0 dBμV emf
	FM (at 12 dB SINAD)	—	—	0 dBμV emf -6 dBμV emf
*5 Less than, HF: Preamp 1 ON, 50 MHz: Preamp 2 ON BW: SSB=2.4 kHz, AM=4 kHz, 60% modulation, FM=7 kHz, 60% modulation				
Selectivity (Filter shape: Sharp)		More than	Less than	
SSB (BW: 2.4 kHz)		2.4 kHz/-6 dB	3.6 kHz/-60 dB	
CW (BW: 500 Hz)		500 Hz/-6 dB	700 Hz/-60 dB	
RTTY (BW: 500 Hz)		500 Hz/-6 dB	700 Hz/-60 dB	
AM (BW: 6 kHz)		6.0 kHz/-6 dB	15.0 kHz/-60 dB	
FM (BW: 15 kHz)		12.0 kHz/-6 dB	20.0 kHz/-60 dB	
Spurious and image rejection	HF bands	More than 70 dB		
50 MHz band	More than 70 dB (Except for ADC Aliasing*6)			
*6 ADC Aliasing frequency: 122.880 MHz - RX frequency				
Audio output power	More than 2.0 W (at 10% distortion with an 8 Ω load)			
TUNER				
Frequency range	1.8 ~ 50 MHz bands			
Matching impedance range	16.7 ~ 150 Ω unbalanced			
Tuning accuracy	Less than 1: 1.5 VSWR			
Tuning time	2 ~ 3 seconds (average)			
	15 seconds (maximum)			

All stated specifications are subject to change without notice or obligation.

Supplied accessories: (May differ depending on version)
 • Control head • AC power cable • BC-267A/E AC adapter
 • Control cable, 3.0 m, 9.8 ft • Desktop stand • Plugs

OPTIONS

Some options may not be available in some countries. Please ask your dealer for details.

<p>EXTERNAL SPEAKERS</p>  <p>SP-33 Wooden box speaker</p> <p>SP-41 Two input lines, High/low filters Max. 5 W input</p>	<p>DESKTOP MICROPHONES</p>  <p>SM-30 Compact, lightweight electret microphone.</p> <p>SM-50 Dynamic microphone with [UP/DOWN] switches and a low cut function.</p>	<p>HAND MICROPHONE</p>  <p>HM-219</p>	<p>REMOTE ENCODER</p>  <p>RC-28</p>	<p>IP REMOTE CONTROL SOFTWARE</p>  <p>RS-BA1</p>
<p>HF + 50 MHz 1 kW LINEAR AMPLIFIER</p>  <p>IC-PW2</p>	<p>HF + 50 MHz AUTOMATIC ANTENNA TUNER</p>  <p>AH-730 Covers 1.8 ~ 54 MHz with a 7 m, 23 ft or longer wire antenna. Max. input: 150 W PEP, 100 W continuous. Controller cable (10 m, 32.8 ft) is supplied with the AH-730.</p>	<p>AC ADAPTER (for control head)</p>  <p>BC-267A/E Same as supplied.</p>	<p>DPD FEEDBACK CABLE</p>  <p>OPC-2501 3 m, 9.8 ft. For use with the IC-PW2.</p>	<p>• USB I/Q Package for HSDSR: Install this package onto a PC to control the IC-7760 from the PC using the HSDSR application. Freely download from the Icom website.</p>

Icom, and the Icom logo are registered trademarks of Icom Incorporated (Japan) in Japan, the United States, the United Kingdom, Germany, France, Spain, Russia, Australia, New Zealand and/or other countries. This product includes "zlib", "libpng" and real-time OS "RTX" open source software, and is licensed according to the open source software license. Some pictures in this brochure include optional accessories and/or non-Icom equipment.

Icom Inc. 1-1-32, Kamiminami, Hirano-Ku, Osaka 547-0003, Japan Phone: +81 (06) 6793 5302 Fax: +81 (06) 6793 0013

www.icomjapan.com

Icom America Inc.
www.icomamerica.com

Icom (Europe) GmbH
www.icomeurope.com

Icom (Australia) Pty. Ltd.
www.icom.net.au

Your local distributor/dealer:

Icom Canada
www.icomcanada.com

Icom Spain S.L.
www.icomspain.com

Icom Asia Co., Ltd.
www.icomasia.com

Icom Brazil
E-mail: sales@icombrasil.com

Icom (UK) Ltd.
www.icomuk.co.uk

Icom France s.a.s.
www.icom-france.com