

KENWOOD



NEXEDGE[®]-ability



NEXEDGE[®]-ability

NEXEDGE is KENWOOD's innovative digital conventional and trunked radio solution, designed to meet the highest demands of today's communications environment and to provide users with a multitude of NEXEDGE-abilities to transform their operations.



Intelligibility *Superior Audio Quality*

Reliability *Fault Tolerant by Design*

Flexibility *Easy Configuration Changes*

Scalability *Expands to Meet Your Requirements*

Manageability *Fleet Management at Your Fingertips*

Durability *Engineered to Meet Stringent Military Specifications*

For many organisations, radios now play a critical role in ensuring everything from smooth daily operations to the coordinated response demanded by critical incidents. In a rapidly changing world, business, industry and public safety communications requirements have evolved from the basics of user-friendly operability to the innovative features enabled by the latest digital technologies. And setting the pace is KENWOOD's NEXEDGE.

NEXEDGE has been proven to be one of the most versatile communications systems available today, capable of satisfying a wide range of government and industry users. Offering conventional operation through to multi-site trunking, as well as paced migration from analog to digital, NEXEDGE is a perfect fit for any organization.

NEXEDGE employs the acclaimed NXDN digital air interface. This open standard is supported by many leading vendors, meaning that NEXEDGE systems are compatible with third-party products that conform to the mandatory features and standard optional features specified by the NXDN Forum.

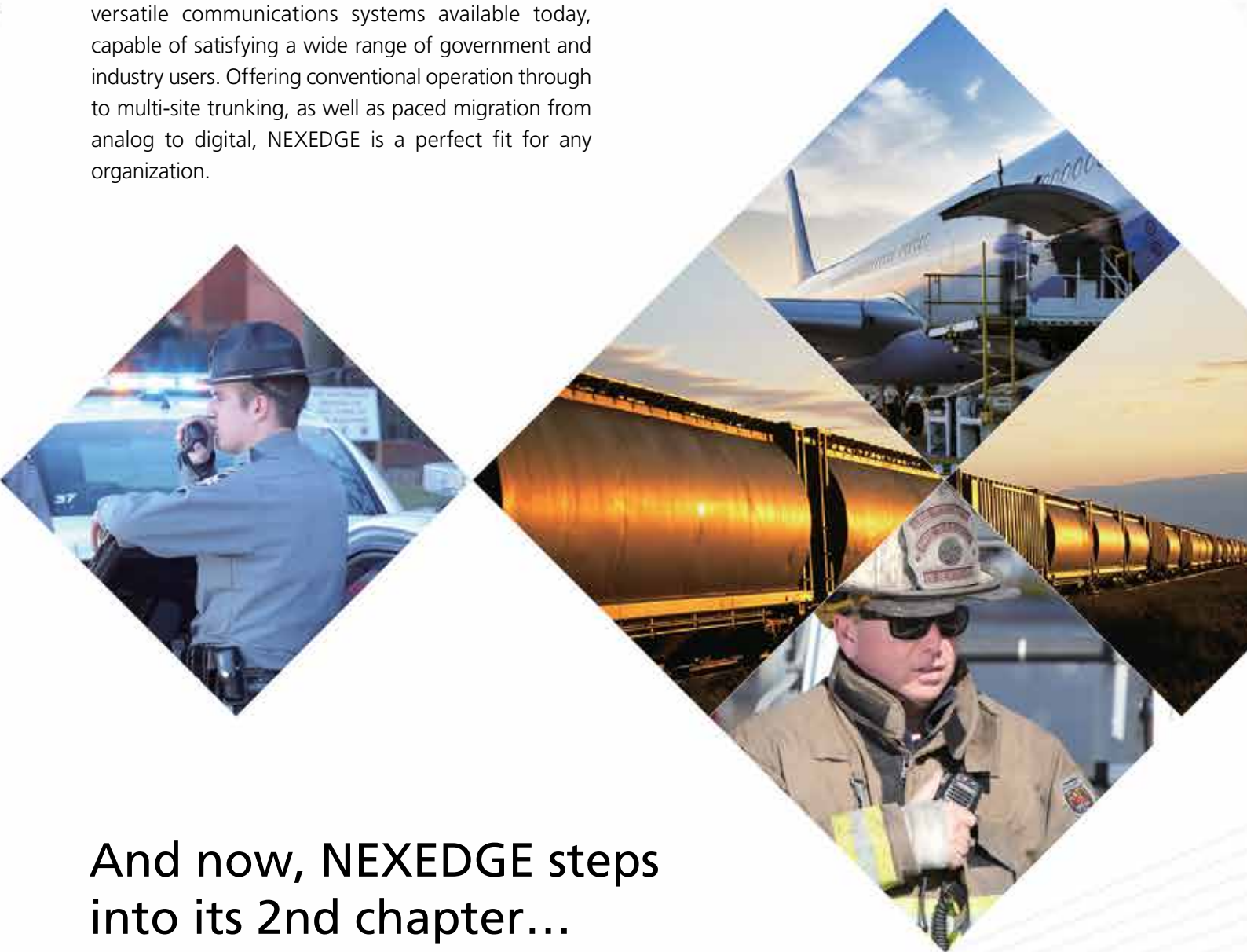

And now, NEXEDGE steps into its 2nd chapter...

Building on this success, KENWOOD has developed NEXEDGE Generation 2 (Gen2). Supporting networks with as many as 1,000 sites, Gen2 delivers a significant boost in network scale and capability, yet also provides full compatibility with your current analog equipment. If you are looking to create a large-scale digital trunked network, NEXEDGE Gen2 has the features, capabilities and performance to

satisfy all your needs. In this brochure where you see this sign is when the new capabilities of Gen2 are described.



Discover the power and versatility of NEXEDGE-abilities. Each of these key digital abilities has been developed specifically to perfectly align with your requirements for a robust and versatile digital network.

Intelligibility

NEXEDGE uses the AMBE+2™ VOCODER, a state-of-the-art voice digitisation and compression technology offering enhanced Forward Error Correction (FEC) and noise reduction for superior clarity at varying signal strengths for all digital call features.



Loud & Clear – Thanks to Advanced Digital Processing

A key element of the NXDN air interface is the AMBE+2™ vocoder which digitises speech while retaining natural voice nuances, performs noise reduction, introduces FEC and compresses voice data to accommodate land mobile radio spectrum bandwidth and data rates. Next, the radio’s digital signal processor (DSP) protocol packages the vocoder, signaling, control, and FEC data together, converting it to a uniquely filtered 4-Level FSK digital waveform that modulates the transmitter. This results in a low bit-error-rate (BER) digital air interface so you get robust communications even in weak signal strength areas.

Superior Audio Clarity with Extended Coverage

As RF signal strength weakens with distance, analogue reception becomes increasingly noisy and intermittent. The low BER of NXDN improves reception in fringe areas, thereby effectively increasing coverage by as much as 20% over FM analogue, resulting in a 50% increase in coverage area for digital 6.25 kHz. Furthermore, even compared to digital 12.5 kHz bandwidth operation such as DMR, the narrower 6.25 kHz bandwidth enabled by the FDMA technology of NXDN extends range by 15%. Receiver filters are narrower and can thus reduce noise. The net result is superior clarity over a 30% wider coverage area.

[Coverage differences in fringe areas]

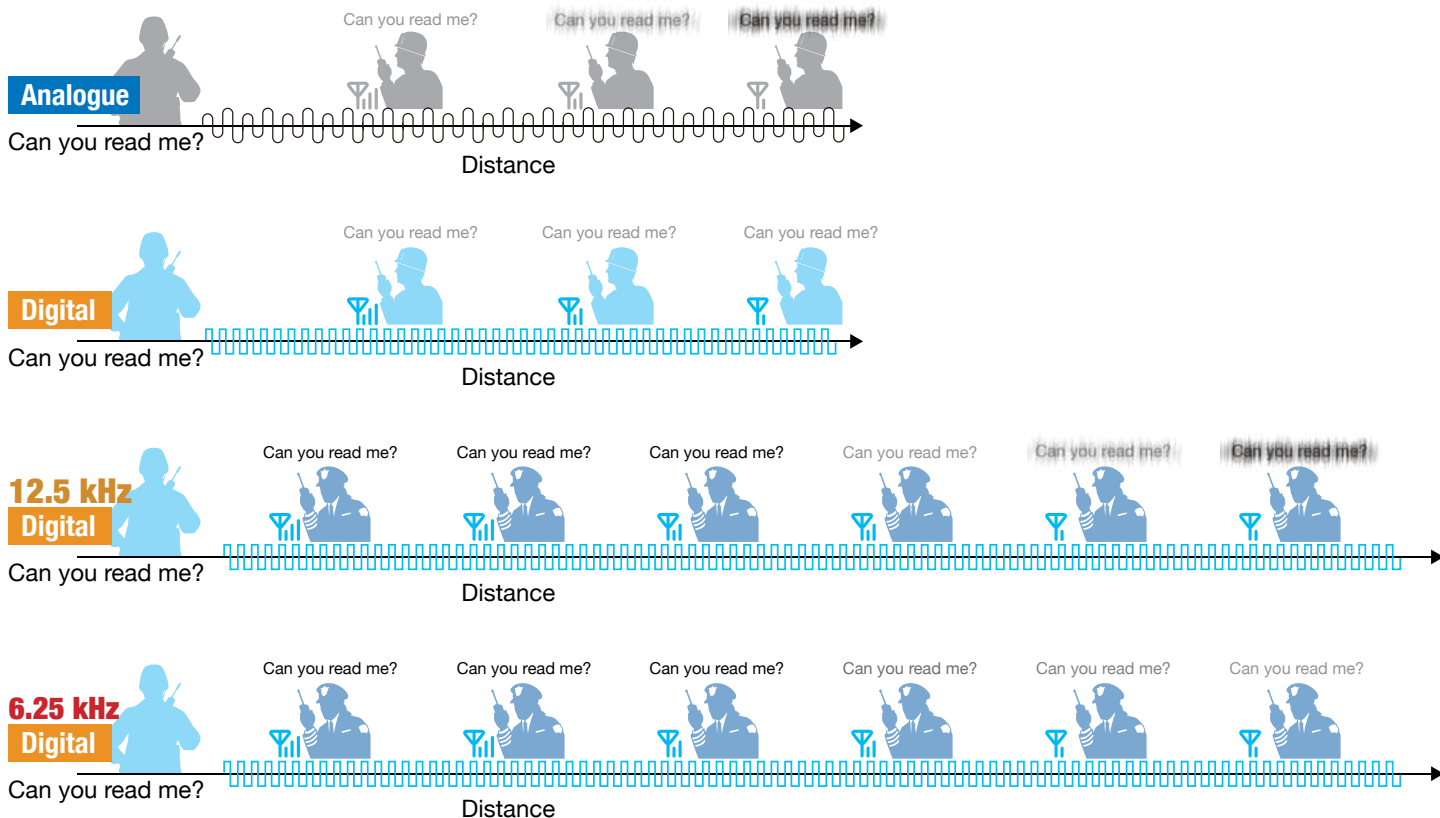

Reliability

NEXEDGE systems use the NXDN digital air interface, a suite of digital communications protocols using 4-Level FSK (4LFSK) modulation capable of operating in 12.5 kHz and 6.25 kHz bandwidths. NEXEDGE voice security enhances personnel safety, reduces risk and thwarts possible information breaches by protecting sensitive communications.



Spectrum Efficiency and Stability

The NXDN air interface is capable of fitting into both 12.5 kHz and 6.25 kHz bandwidth channel operation to ensure rock-steady frequency stability, exceeding all regulatory and emissions mask requirements in all bands.

What's more, the narrower 6.25 kHz bandwidth mode offers a high CNR (carrier-to-noise ratio), so radios can communicate over greater distances.

[NXDN 12.5 & 6.25 kHz]

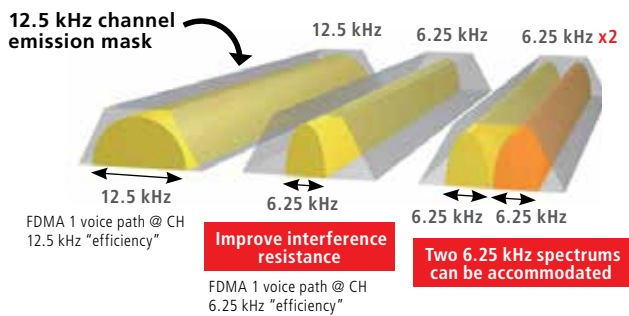

Flexible Channelisation

NEXEDGE equipment will program on any channel center or offset (2.5, 3.125, 5, 6.25, 7.5 kHz PLL channel steps), providing more potential to find frequencies, which is important where narrower channel migration is being forced or there is a need to maximise use of geographical licenses and use split-channels where permitted.

User Validation

All NEXEDGE system configurations validate unit and group IDs for subscriber access. Commercial and private operators can easily activate & deactivate subscriber units via remote programming or system management software. This is ideal for organisations with frequent personnel changes, so radios can be used by contractors, vendors and seasonal/temp workers.

ESN Radio Validation

Each NEXEDGE subscriber radio has a unique and unchangeable factory embedded Electronic Serial Number (ESN) that can be validated for trunked system access. In the event a radio is lost, stolen or compromised, the ESN can be disabled, enabling all other radios to communicate in their talk groups without disruption. The operator's original ID numbering system is preserved because only one subscriber unit is disabled and talk groups shared by many users are unaffected.

Voice & Data Security

The NXDN digital air interface offers inherent security against casual electronic eavesdropping, and subscriber units also include the NXDN 15-bit key scrambling function for secure voice & data. IP links are further secured through encrypted VPN tunneling to authenticate and encrypt all inter-site communication. Optional AES & DES encryption modules provide government/military-grade security against more sophisticated eavesdropping technologies.

If a module is installed in any other radio unit, the encryption keys are automatically erased. In addition, if more than 15 radio-password attempts are made, the module's encryption keys are also erased, preserving the fleet's current secure voice integrity.

[Secure Voice]

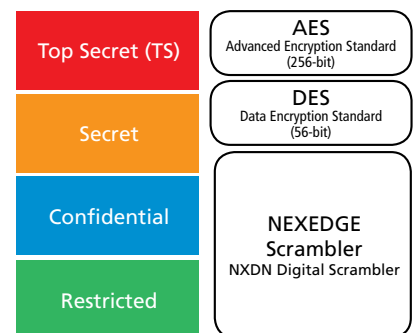

Radio Password Protection

Each radio can have a required password to authorise operation, thus adding an extra level of security against unsanctioned radio use.

Flexibility



NEXEDGE supports both NXDN digital and analog modes via a common transceiver technology, which creating a self-paced migration path to accommodate budgetary, administrative, organisation and timeline requirements.

Conventional Mixed Mode

Current analogue and NXDN digital fleets can share the same frequency in conventional Mixed Mode, continuing service to aging analogue fleet radios as new digital radios are deployed. NEXEDGE radios, capable of both conventional analogue and digital operation, can talk to both old and new radios. The Mixed Mode operation is available in base, repeat and direct modes in the following bandwidth combinations: 25, 20*or 12.5 kHz analogue with 12.5 or 6.25 kHz NXDN (25 kHz mode capable equipment is only available where permitted by government regulations).

Additionally, all NXDN digital modes use the same Class-C power amplifiers and site management equipment used for current analogue stations, ensuring high ROI and a wide range of supplier choices.

**Europe*

Trunked Channel Shared Mode

NEXEDGE trunked system traffic channels can be shared with existing external analogue conventional or analogue trunked logic controllers, extending service to analogue fleets as they transition to NXDN trunking.

Telephone Interconnect System

The Interconnect Adapter (KTI-4), connected to a NEXEDGE Trunked System, converts analogue telephone voice to/from digital, enabling two-way communication between a telephone and a radio. It connects to an analogue PABX/PSTN system through analogue telephone patch equipment.

[Telephone Interconnect System]

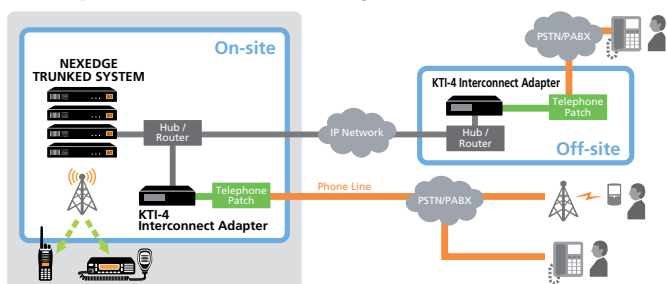

OAA: Over-The-Air-Alias

A calling unit's User ID (UID) alphanumeric alias is sent over the air and displayed on the receiving unit's LCD, so there is no need to program every fleet alias in every radio.

OTAP: Over-The-Air-Programming

The NEXEDGE OTAP Manager software (KPG-150AP/180AP) provides wireless programming for subscriber units in the field. Over-the-air changes to large fleets will result in huge savings by cutting down on extensive travel, labour and fuel costs as well as in lost productivity caused by radio downtime.

OTAP features include:

- Programs Subscribers Over-the-Air
- Full & Partial Programming
- OTAP Session Scheduling
- Auto Retries & Pass / Fail Logging
- Fail Safe
- Works with all NEXEDGE Subscribers
- Adds savings for operators and customers.

[NEXEDGE OTAP (KPG-150AP/180AP)]

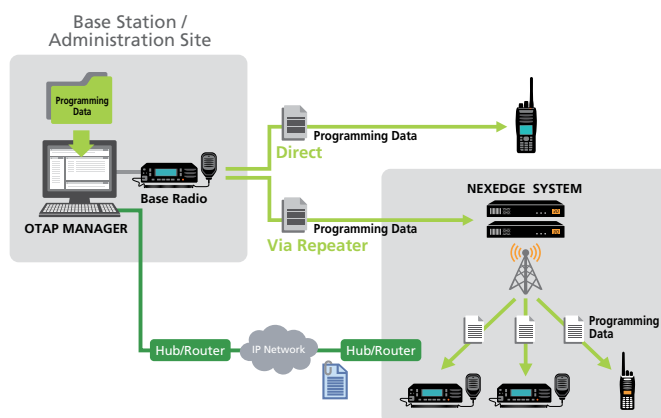

Linux Server-based System Architecture



NEXEDGE Gen2 employs a Linux server-based system architecture that offers a level of reliability that allows you to expand your setup and control capabilities. This enables superior, fine-grained control of networks, systems, sites and peripheral equipment – including the ability to modify a setup and conduct maintenance/monitoring remotely.

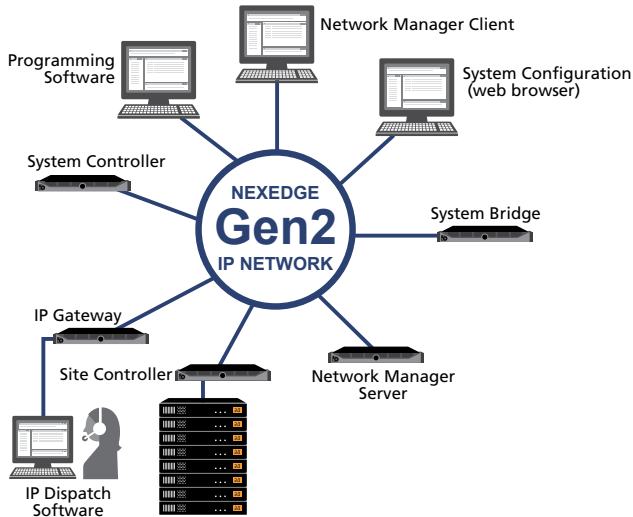

Direct Frequency Assignment (DFA) for Efficient Site/Channel Addition



With the inherent flexibility of NEXEDGE Gen2, you can always keep your system up to date easily and quickly. Unlike NEXEDGE Gen1 models that require collecting every single subscriber unit on the network to add a new channel/site, Gen2 features DFA – Direct Frequency Assignment – simplifying the procedure to ensure that as soon as new frequencies are added to the network, all equipment and subscriber units connected to the network are notified automatically. No radios have to be called in, which means zero downtime for site managers and SMR operators.

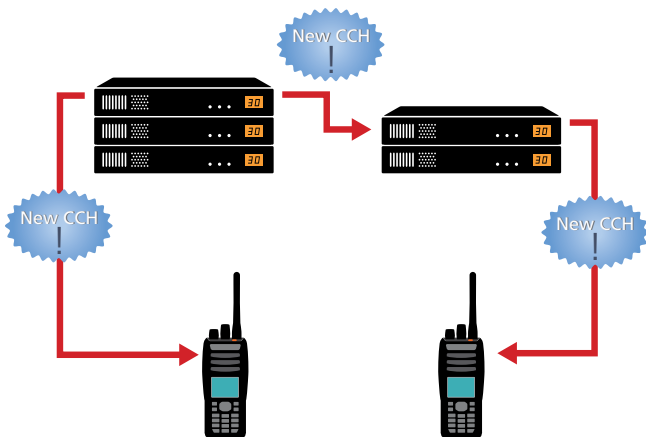

IP Interface, Console Gateway



Up to 100 consoles can link to a single IP gateway (using the KPG-1002GW gateway software) so a single network can connect a maximum of 1,000 consoles. Call recording and logging interfaces are available.

Yet another example of the flexibility of a NEXEDGE Gen2 system is that it is SNMP-compatible throughout the network.

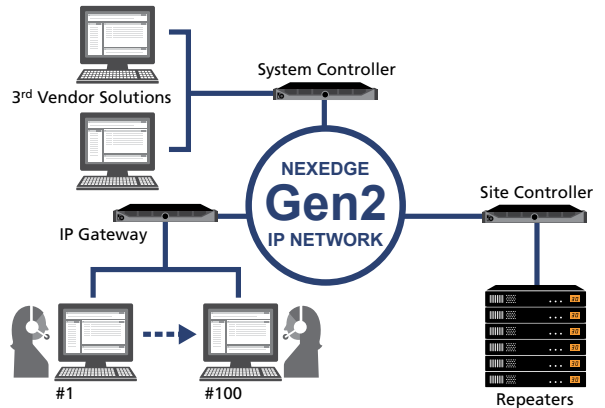

Fleet Priority Channel – Secured Priority Channel Allocation



For demanding mission/operation-critical users, it is essential to have a system that offers top-notch security 24/7. Mission critical users can put their full trust in the NEXEDGE Gen2 system because they can assign a secured priority channel to a specific traffic channel (TCH) – for a group, console, or other peripheral. Group members will have priority access at all times, which is ideal for public safety applications. Gen2 further enables private system applications, facilitating the development of new solutions – for example, using a Secured Priority Channel for SMR network channel leasing to end users.

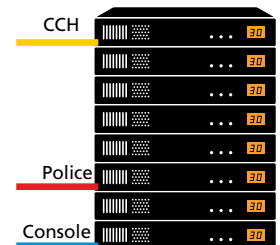

Dual Functional Channel/ Non-Dedicated Control Channel



Channel complex systems require a dedicated control channel (CCH), but it can be difficult to set up such a channel in a way that is cost-effective. However, NEXEDGE Gen2 employs an elegant solution: the CCH and TCH temporarily exchange roles to expand air capacity. This Dual Functional Channel enables you to receive the same level of performance provided by a dedicated control channel but without having to make a large investment. This approach also maximises traffic capacity without increasing the number of frequencies, and maintains an even load distribution on the repeaters, a solution that makes sense for sites with limited traffic.

Scalability

As well as traditional conventional systems, conventional IP networks and trunked networks, NEXEDGE allows you to link up to 1,000 sites (up to 24 networks).



Digital Conventional Systems

NEXEDGE conventional systems offer capabilities beyond analogue conventional systems. With large unit ID and talk group ID capacity, operators can identify and segment different departmental/agency groups and sub-groups on shared channels. Mixed Mode allows service to both analogue and digital fleets at the same time.

- **RAN (Radio Access Number)** base units include a 16 RAN capacity conventional repeater controller for 16 user group site sharing (RAN range: 1-64; this is similar to CTCSS/DCS use in FM).
- **1,000 GIDs** Large talk group ID capacity for group selective calling.
- **1,000 UIDs** Large unit ID capacity for individual selective calling.
- **Mixed Channel Type** FM & NXDN conventional units can share the same RF channel. Both subscriber units and bases demodulate incoming analog FM or NXDN digital calls and talkback or repeat in the same mode (combination with any bandwidth).

[Conventional System]

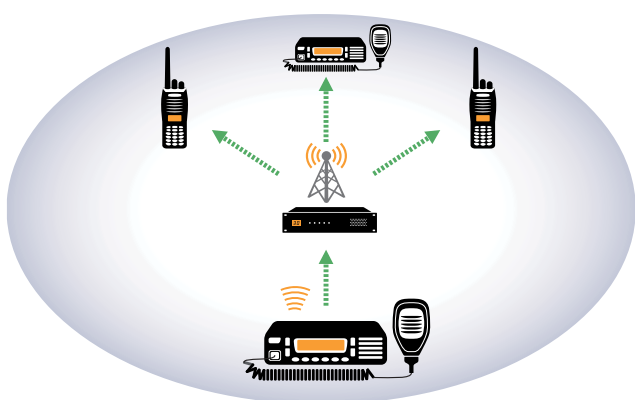

Digital Conventional IP Networks

NEXEDGE Conventional IP Networks offer wide area coverage or coverage fill-in extensions.

- **16 or 48 Site Configurations** NEXEDGE Conventional IP networks link up to 16 or 48 digital conventional repeaters into one system for wide area coverage or coverage fill-in extensions.
- **Beacon Signals** As users roam throughout the network, subscriber units use the beacon signals to choose the best repeater for communications.
- **Normal or Automatic Site Roam (per Zone)** Subscriber zones can be programmed for "Normal Channel Select," for traditional conventional operation, and/or "Automatic Site Roam," which allows subscribers to scan for site beacon signals to lock on to in order to make or receive network calls.
- **Receiver Voting** Voting systems extend the portable talk-in range of an NXR-710/810 conventional repeater by utilising a constellation of satellite receivers linked to the repeater site. Portable signal strength data (RSSI) is sent via IP link to the repeater site which compares and selects the receiver site with the best audio quality for re-transmission.

[Conventional IP Network]

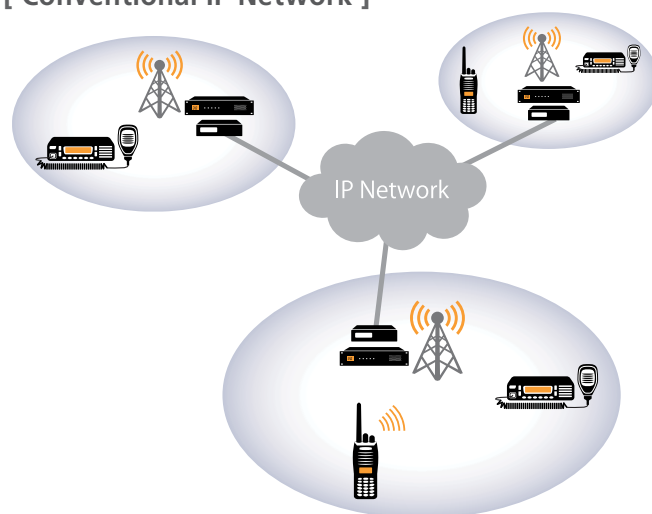

NXDN Type-C Trunked Systems

Specified as the full-featured digital protocol by the NXDN Forum, NXDN Type-C has been used for NEXEDGE since 2007. As well as Type-C it is known as Control Channel based or Centralised Control trunking, which is controlled centrally using a dedicated control channel that is continuously transmitting and receiving. As with MPT 1327, registration is required.

Type-C trunked systems provide increased call capacity, enhanced call capabilities, improved security and faster communications with less user interaction than conventional systems. The system automatically assigns channels for faster and more efficient use of spectrum, allowing users to concentrate on the job at hand.

- **System Call Queuing** Stack call requests and processes calls when a channel becomes available. System operators can assign higher queue priority to certain users and preempt lower priority users for more important dispatch and emergency calls.
- **Priority Monitor** Monitor for up to 4 high priority talk groups and automatically switches radios to a higher priority call, such as from a dispatcher or supervisor.
- **Privacy** Assures complete privacy for group and individual calls. Other users on the system cannot monitor calls.
- **Late entry** Subscriber units may join a group or individual call already in progress after powering on or upon entering the system coverage area.
- **Message Trunking** Users are granted access to a traffic channel for the length of a two-way call to reduce interruptions by utilising fewer system resources.
- **Transmission Trunking** Optimises channel resources during peak traffic hours by allowing channel access only during each push-to-talk.

NXDN Type-D Trunked System

Economical alternative to the Type-C trunked system, Type-D trunked system is based on digital LTR® protocol specified by the NXDN Forum. Unlike Type-C trunking, there is no dedicated control channel: trunking is under the control of the home repeater assigned to each radio. Similar to LTR, there is no need for registration.

[Trunked System]

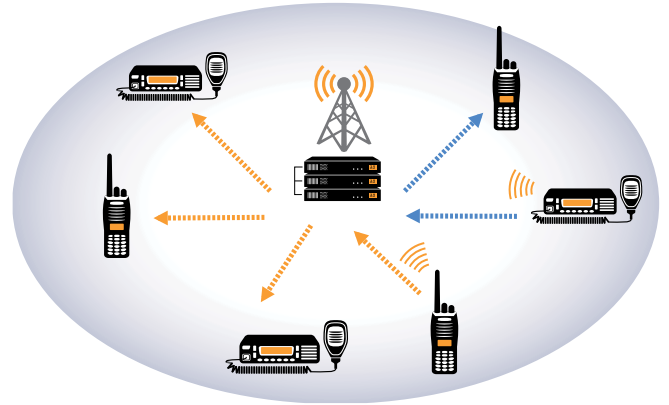

Digital Trunked Wide Area IP Networks



The network option leverages the power of IP to link multiple digital trunked sites (up to 1,000 with NEXEDGE Gen2) for wide area roaming and calling — across a campus, city, country, or region. Scalable networks can be created over existing IT assets, private microwave, spread-spectrum links or carrier services using standard 10/100 Base-T Ethernet switches and routers. The 60,000 group ID and unit ID network capacity is sufficient for large organisations and multi-user system sharing.

Tornadoes and forest fire happen without warning, and NEXEDGE makes it possible to build a highly flexible system to respond swiftly and dynamically to immediate challenges.

Subscriber units use advanced control channel hunting algorithms, RF signal strength and digital signal quality monitoring to automatically determine the best site for accurate and resource-sensitive roaming and registration decisions.

- **All Call** Calls all fleets or all units in a fleet in emergencies and for critical incident response.
- **Remote Group Add** Adds a new GID to subscriber units remotely over-the-air to form a workgroup for emergencies, special events, special operations or critical incidents.
- **Control/Traffic Channel Switching** Designates a Traffic Channel as a new Control Channel should the original become disabled. Disabled Traffic Channels are automatically removed from service.

[Digital Trunked Wide Area IP Network]

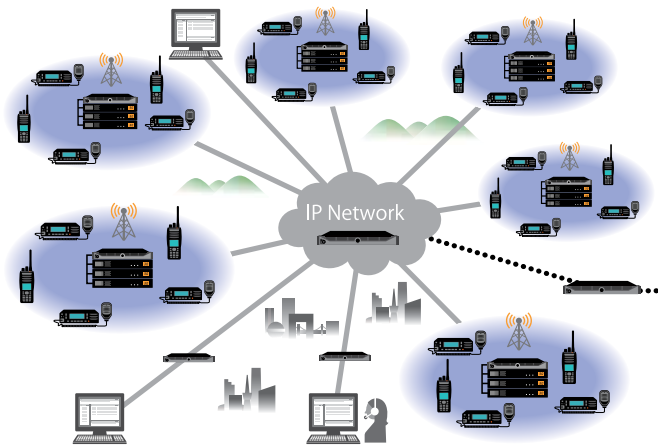

Multi-system Roaming – Highly Scalable IP Network



NEXEDGE Gen2 Multi-system Roaming Gateway Server has been developed to meet the needs of operators expanding to large-scale regional systems. Using the Multi-system Roaming, it is possible to connect to different trunked systems operated by other SMR/PAMR operators based on Gen2. Users will be able to enjoy seamless auto-roaming connection among individual networks with different system codes. By supporting the voice and data features of a local network across a large-scale system, NEXEDGE Gen2 serves the requirements of SMR and private operators for state-wide, multi-state or national systems.

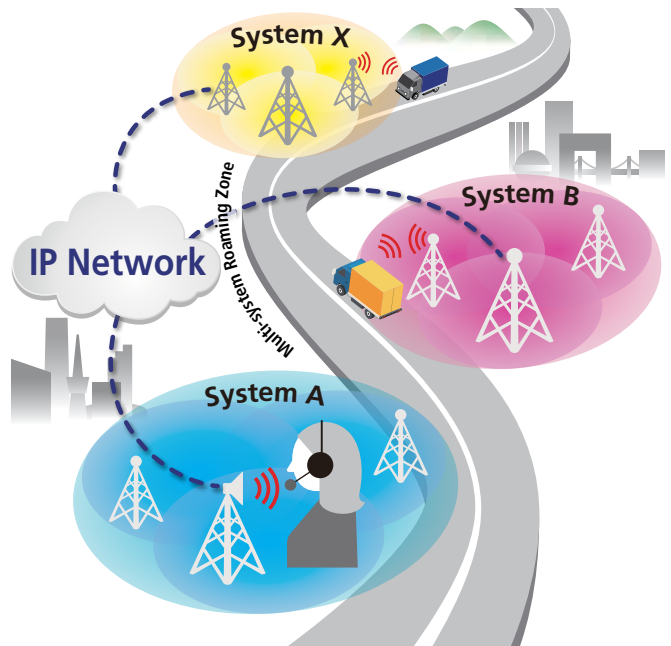

Extended Coverage

Because an RF signal weakens with distance, analogue reception becomes increasingly noisy and intermittent. The low BER of NXDN improves reception in fringe areas, thereby effectively increasing range by as much as 20% over FM analogue, resulting in a 50% increase in coverage area for digital 6.25 kHz.

Compared to digital 12.5 kHz bandwidth operation, the narrower 6.25 kHz bandwidth enabled by the FDMA technology of NXDN extends range by 15%. Receiver filters are narrower and can thus achieve superb C/N (carrier-to-noise) ratio. The net result is superior clarity over a 30% wider coverage area.



6.25 kHz

At a total of 2150 sq. miles coverage:

6.6-mile radius per site / only **16 site total**



12.5 kHz digital system

At a total of 2150 sq. miles coverage:

5.8-mile radius per site / **21 site total**

Note: Map and coverage areas shown are simulated picture and not to scale.

Manageability

NEXEDGE Application Software and Dispatch System effectively and efficiently manage your fleet.



Centralised System Management

Sophisticated network system management software reduces operation and maintenance costs. It offers such features as remote programming, firmware uploading, subscriber unit access management, monitoring and diagnostic capabilities – all from a secure Windows®-based application via direct connection, IP connection or dial-up modem. Access is limited to authorised personnel only .

- **Subscriber Privileging** UID/GID validation, Class-of-Service entries of 5,000 UID/GID each for Gen2 or 127 UID/GID each for Gen1; 5,000 Fleet UID/GID lists permit operators to grant certain access privileges, call types, inter-site call capabilities and queue priority to any groups and/or individuals on a system.
- **Real-Time Activity Monitoring** Activity dashboard maintains activity records for troubleshooting.
- **Call Logs** Operators can download detailed call activity of any channel, site, individual or group for traffic, security and incident analysis.
- **Channel Loading Graphs** Track usage and blocking statistics to identify possible system traffic/capacity issues.
- **NXR Diagnostics** Operators can remotely monitor each NXR unit's hardware and Ethernet network interface to identify possible problems at any site.
- **NXR Firmware Uploading** Operators can remotely update operational firmware in all NXR units without having to drive to a site.

NEXEDGE Repeater Monitor

The NEXEDGE Repeater Monitor provides around-the-clock remote IP monitoring of all repeaters on an NXDN single-site or multi-site trunked network and on NXDN conventional IP networks. This software alerts supervisors and technical personnel of systemic problems or failures at any site. The repeater monitor can be set to sound a PC alarm and send multiple emails or SMS text messages upon receiving an alert. All events are recorded in a log file.

- Repeater Diagnostics Via IP
- WAV File Alarms
- Email/SMS Alert Notifications
- Log File Download
- Single-site Trunked & Multi-site Networks
- Conventional & Conventional IP
- Network Link

Notification When a trunked network IP link is disrupted, the site reverts to single-site trunked operation and a network link message can be broadcast over the air, while an alert tone is sounded on the radios of the system operator and on-call technician.

NEXEDGE Repeater Monitor Software for iOS

This iPhone/iPad app can notify staff of remote repeater incidents. Note that it is designed specifically for use with the KPG-149RM PC software. Owing to iOS restrictions, the app is unable to detect incidents while the smart device is in sleep mode or when the app is operating in the background, but since the PC-based KPG-149RM monitors repeaters around the clock, it can notify the smart device user via email (Alert Mail) at any time.

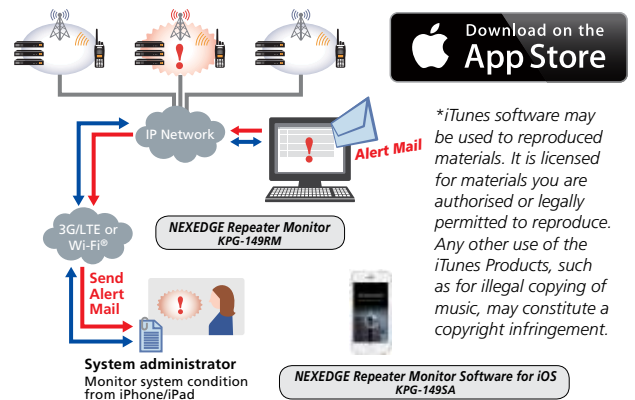

Network Manager System & Client for Gen2



NEXEDGE Gen2 employs a server-based network design with a system controller to ensure efficient system management. The addition of Network Manager System & Client enables comprehensive monitoring of large-scale systems with multiple access points. Network assets are managed using the SNMP protocol, while IP assets are managed with a single program. In addition to NEXEDGE server and repeater monitoring, IP asset and network monitoring is also possible; this includes network traffic and load, network path, subscriber registration, latency, event and error monitoring. Other functions include log acquisition and analysis; call log acquisition and analysis by group, site and call type; reporting and alert settings.

Use of SNMP provides flexible means for status monitoring of network hardware such as routers and switches, as well as Windows and UNIX servers. It also facilitates resource, performance and traffic monitoring. The system is compatible with commercially available network monitoring applications.

- KPG-1003NS Network Management Server Software
- KPG-1004NC Network Management Client Software

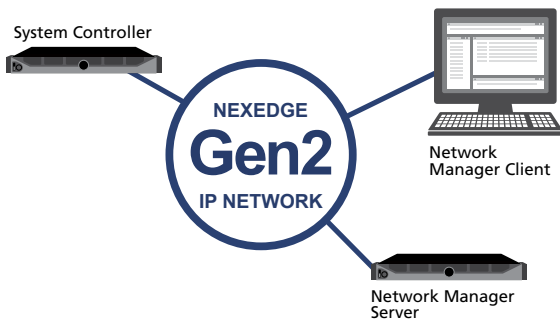

NEXEDGE AVL & Messaging

KENWOOD's KAS-10 dispatch application easily integrates with a NEXEDGE control station radio for operation on all system types or as a virtual PC radio via an IP connection to a NEXEDGE network. Voice messaging and AVL functions run independently.

- 999 Mobile ID Capacity
- NEXEDGE Conventional & Trunked Systems
- Analogue Conventional & LTR® Systems
- Microsoft® MapPoint® 2006/2009/2010/2011 Mapping
- Google Earth™ Maps (KML Output)
- NEXEDGE VoIP Dispatch
- 100 Group Scan with 4 Priority Monitor ID's
- NXDN Voice Scrambling
- Dispatch Console Window

[KAS-10]

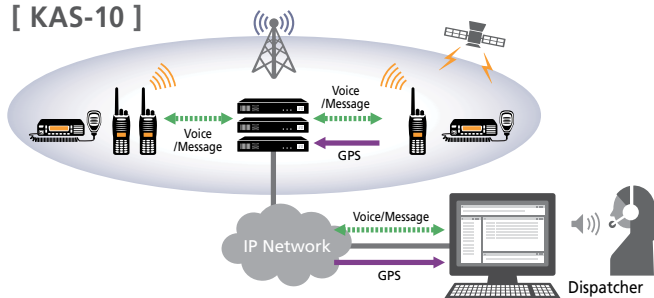

Increased GPS Capacity / GPS Report Channel



GPS is a widely used tool to track the position of personnel and vehicles. NEXEDGE Gen2 further enhances GPS operation to facilitate management. The System Controller is aware at all times how many GPS-equipped subscriber units (SUs) are on duty, and when a new SU is registered, the controller assigns a reporting frame and traffic channel.

Improvements to the air protocol minimise data overhead, maximising traffic/data capacity while reducing GPS data processing time.

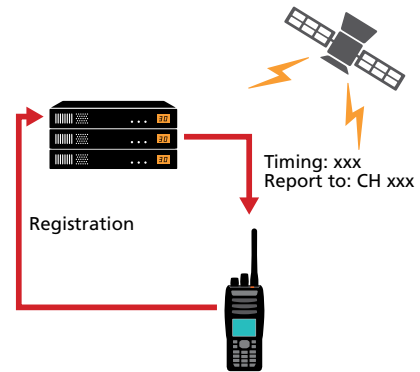

NEXEDGE Dispatch

KENWOOD's NEXEDGE Dispatch System is a dedicated end-to-end, IP-based telecommunications console system designed for medium to large operations.

- IP Gateway Connection to NEXEDGE Trunked Repeater
- Group, Individual, Emergency, Status, Encryption
- Analogue/ NEXEDGE Conventional Radio Gateway
- Patching at Dispatch Console
- Network Redundancy & Hot Standby Provide 99.999% Availability
- System-Wide Aux I/O
- Supports Distributed Console System Design

[NEXEDGE Dispatch System]

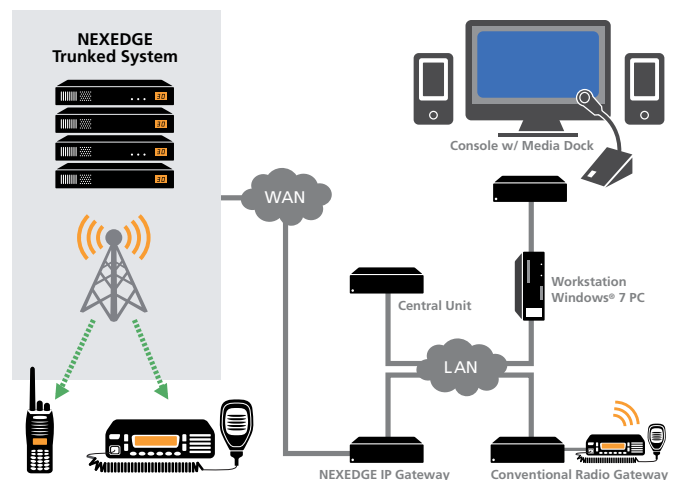

Wireless Image System

This innovative system consists of a monitor station (KVT-11) and a base station (KAS-11) linked via NEXEDGE digital transceivers*. Still images are transmitted from the remote camera to the base station computer, which serves as the control and monitoring center. Several sites can be monitored simultaneously.

**Models compatible with transparent mode.*

- Remote Wireless Camera
- Base Monitoring / Image Viewer
- NEXEDGE System Compatible
- 900KB VGA-Res Color or B&W Images
- MPEG-4 AVC/H.264 Video Compression
- Transfers in 1.5 Minutes or Less

[Wireless Image System]

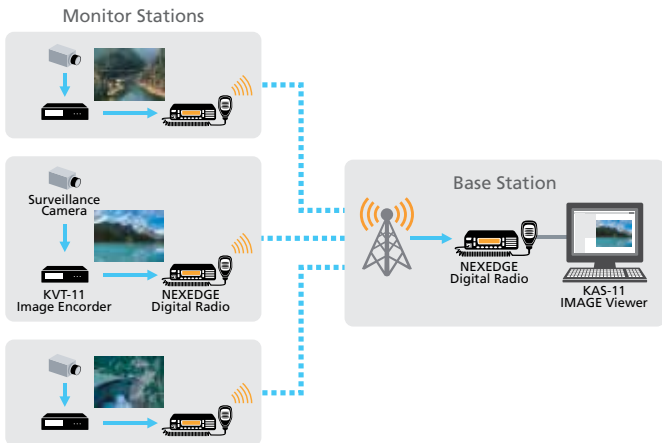

Call Preemption/Interruption for Consoles



Supervisors and console operators – for example, in airport control towers and taxi dispatch centers – can use this feature, to ensure that console calls have priority. If there is no traffic channel available, the console can take over a channel: radios in operation will automatically stop ongoing call transmission/reception, and the console will be able to communicate directly with their users. Call interruption facilitates emergency alerts or instructions to be issued to a large number of users at the same time, making this feature also useful for public safety.

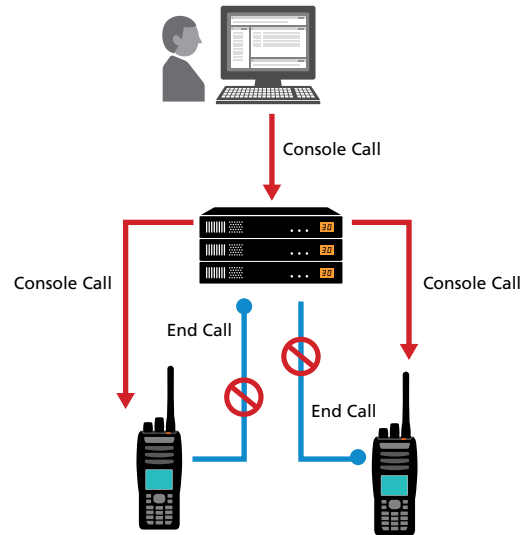

Browser-Based Multi-Access Configuration Tool



This browser-based configuration tool replaces the KPG-110SM System Manager. You can now use a PC or even mobile device to monitor, in real time, the access status of multiple users from multiple login points with access control. Upload a firmware update to the System Controller for an automatic update of all repeaters, assuring that all repeaters are constantly operating on the latest firmware. This ensures that all repeaters on the network will always have the latest firmware version. Log management via the System Controller is also possible. And since this is a browser-based approach, flexibility is assured: as long as you are connected to the network, you can access the system from anywhere to remotely configure network settings.

Schedulable Stun/Kill



To prevent unauthorised access and/or theft of radios, the electronic serial numbers are screened by the system. When a radio is keyed up, the ESN is constantly screened; if an unauthorised person is trying to access the network, the operator has the option to initiate a stun or kill to disable the radio. Prescheduling is convenient for setting up rental subscriber units. For instance, you can set up to renew contract when a payment is made. The radio can be disabled when the contract ends, or the radio not being returned on a specific date. Configuration is browser-based to ensure flexibility.

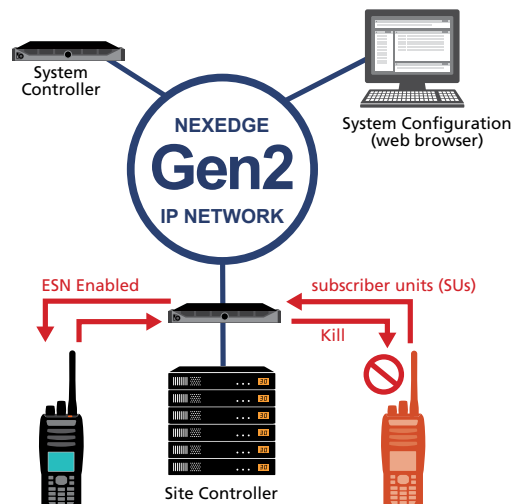

Durability



NEXEDGE Repeaters, Base Stations, Portables, and Mobiles must meet the demanding needs of heavy industrial applications and tough job requirements. Quality control is ensured by subjecting each new model to a battery of stringent tests before it is launched. All our products are compliant with MIL-810 and IP54/55 weather-proofing.

Rugged Design to Support Mission-critical Operations

Key to the development and manufacturing process, we subject KENWOOD radios to numerous tests of durability. Under rigorous conditions, the radios are subjected to water immersion, temperature extremes and impact tests. All NEXEDGE radios are both MIL-STD and IP certified.

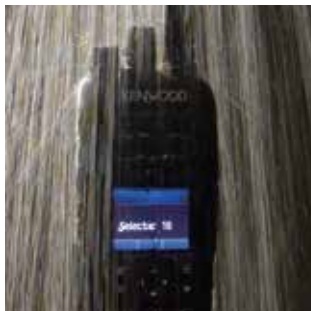

Heavy Rain Test



Splash Test



Drop Test



Extreme Temperature Test



Key Push Test



Immersion Test

Intrinsically Safe: Worldwide Directives/ Certifications for IS/EX Radios

FM Approvals is a certified agency authorised to conduct internationally recognised ANSI/ISA testing for Intrinsically Safe Apparatus. In China, CQST is a safety certification standard for electrical products to be used in hazardous areas. IEC Ex is an International certification system for Ex products Scheme. ATEX directives are EU standards for equipment to be used where there is a potential risk from explosive atmospheres; certified products eliminate the risk of ignition and ensure safe operation.



Note: Please read the IS Manual very carefully before using the IS radio. The radio/battery combination must be strictly observed. There must be no substitution of items, even if the substitute has been previously approved for use with other KENWOOD communications equipment. Do not use the radio with any battery or accessories or options in a hazardous atmosphere unless they are specifically certified for such use; otherwise, an explosion or fire could result. Charge batteries only in areas known to be non-hazardous (in fresh air).

IS certified models are: NX-200, NX-300

ATEX certified models are: NX-230EX, NX-330EX;

*Check with your local KENWOOD dealer on specific models that may be compatible.**

**Model availability may vary depending on region/country.*



Going Forward

The **KENWOOD SOLUTION DEVELOPERS Program** welcomes experts in software and hardware development that are interested in creating new solutions for NEXEDGE radios and systems. This initiative is facilitated by the **KPT-110SDK Software Development Kit**.



Solution Categories:

1) AVL, GPS & Tracking

- Ability to easily and accurately pinpoint the location of a mobile caller or vehicle in transit to manage assets.
- Location-based services used for emergency purposes as well as enhanced business applications such as location-sensitive billing, traffic updates, fleet management and asset & people tracking.
- Numerous options for mobile positioning available.

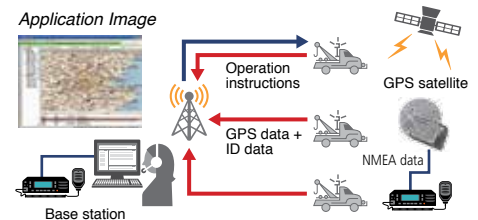

2) Event Logging & Voice Recording Solutions

- Software to log and control a private radio network.
- Offers fully customisable Event Logging applications.
- Basic logging: PTT, status updates, auto transmitting, emergency signals, etc.
- Advanced logging: Engine data of a vehicle such as speed, location, direction, operational duration, temperature, fuel consumption, RPM and odometer; Operator logs to track hours worked and productivity, etc.
- Dedicated Voice Recording solutions to log individual or group voice traffic in a NEXEDGE trunked radio system.
- Recorded voice can be played back and/or stored on different media such as hard drives or CD-ROM/DVD.

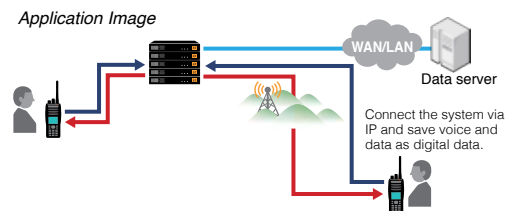

3) Dispatch and Monitoring Solutions:

- Diverse Dispatch and Console solutions from low to high tier and from operation critical to mission critical applications.
- Intelligent UIs, advanced tools, network health monitors, and simple desktop consoles.
- Ensures the highest levels of interoperability, scalability and usability.

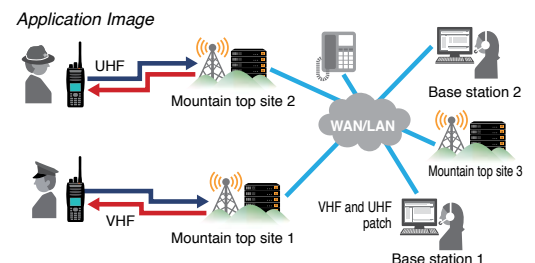

4) Gateway Solutions

- Connect a network to other radio systems, VOIP, Satellite or Cellular technologies.
- Use smartphones to monitor the status of a radio network and operations from remote location.
- Access to phone systems (e.g. PABX, PSTN, or x-system).

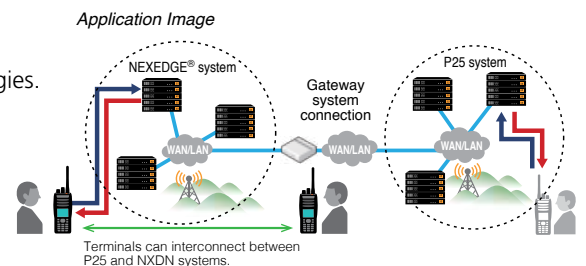

5) Messaging Solutions

- Send emails and text messages to a radio.

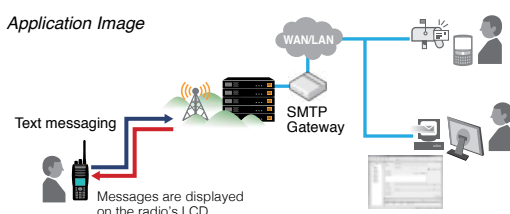

KPT-110SDK (ver. 2.0)
Software Development Kit

KAS-10/20
AVL and Dispatch Software

Dedicated website and brochures are available
<http://kenwoodsolutiondevelopers.com/>

Portable Radios

Drawing on decades of KENWOOD engineering expertise, NEXEDGE portable radios stand out for their superb operating ease and impressive performance.

NEXEDGE Multi Digital & FM Portable Radio
NX-5200/5300



NEXEDGE Digital & FM Portable Radio
NX-200(G)/300(G)



Display		Color 1.74" (240 x 180 pixels) Transflective TFT LCD	14-character alphanumeric aliases & backlit dot matrix LCD
Keypad		Full-key/Standard key	Numerical-key/6-key/Non-key
Frequency range	VHF	136-174 MHz (NX-5200)	136-174 MHz (NX-200(G))
	UHF	400-470 MHz (NX-5300)	400-470 MHz (NX-300(G))
RF output	VHF	6/1 W (NX-5200)	5/1 W (NX-200(G))
	UHF	5/1 W (NX-5300)	5/1 W (NX-300(G))
CH-GID/Zones		Max. of 4,000 CH-GID 512/128	Models with LCD: 512/128 Models w/o LCD: 64/4
Common air interface		NXDN, DMR, P25 (Phase I & II), & FM	NXDN & FM
Vocoder		AMBE+2™	AMBE+2™
Signaling modes		Fleetsync, MDC-1200, QT/DQT, DTMF	Fleetsync, MDC-1200, QT/DQT, DTMF, 5-Tone, MPT
NXDN digital trunking		Gen2 & Type-C	Gen2 & Type-C
P25		Phase I & II	—
GPS		Built-in	Built-in for models with suffix G (Requires optional KRA-43G/44G antenna)
IP code		IP54/IP55/IP67/IP68	IP54/IP55/IP67

Intelligent Battery Management System – Smart Design for the NX-5200/5300 Portables

You can seamlessly manage multiple batteries to extend battery lifetime and ensure that the batteries are optimally maintained. Using the Intelligent Battery Series, Intelligent Charger, and a PC installed with Battery Reader Software KAS-12, up to 60 Rapid Chargers can be chain-connected to the PC for status monitoring of batteries. Also, as an enhanced option of the KAS-12, up to 5000 batteries can be managed including storing the data acquired from a battery reader.

• Intelligent Battery Series



KNB-L1
(Li-Ion 7.4V/2000 mAh)



KNB-L2
(Li-Ion 7.4V/2600 mAh)



KNB-L3
(Li-Ion 7.4V/3400 mAh)



KNB-N4
(Ni-MH 7.2V/2500 mAh)

• Intelligent Charger KSC-Y32

Battery conditions are displayed in illuminated color indicators on the charger, which are also displayed on a connected PC with the same color scheme. Red, yellow and green LEDs provide users with at-a-glance information for comprehensive battery management.



NEXEDGE Digital & FM Portable Radio
NX-220/320



NEXEDGE Digital & FM Portable Radio
NX-230EX/330EX



13-segment & backlit 8-digit LCD	14-character alphanumeric aliases & backlit dot matrix LCD
Numerical-key/4-key/Non-key	12-key
136-174 MHz (NX-220)	136-174 MHz (NX-230EX)
400-470 MHz (NX-320)	400-470 MHz (NX-330EX)
5/1 W (NX-220)	1.2 W (NX-230EX)
5/1 W (NX-320)	1.2 W (NX-330EX)
Models with LCD: 260/128 Models w/o LCD: 64/4	512/128
NXDN, FM & dPMR	NXDN & FM
AMBE+2™	AMBE+2™
Fleetsync, MDC-1200, QT/DQT, DTMF, 5-Tone, MPT	Fleetsync, MDC-1200, QT/DQT, DTMF, 5-Tone, MPT
Gen2, Type-C & Type-D	Gen2 & Type-C
—	—
Requires optional KMC-48GPS speaker microphone	Built-in (Requires optional KRA-43G/44G antenna)
IP54/IP55	IP65/IP67

• Intelligent Battery Management System

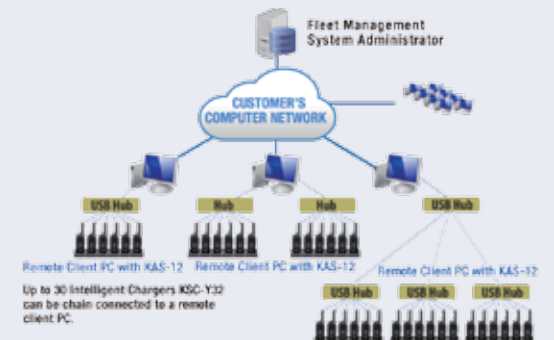
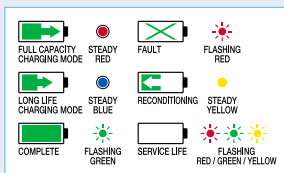

Mobile Radios

Offering intuitive operation with ergonomic controls and a high-visibility display, NEXEDGE mobile radios provide extensive FM/digital capabilities on the road.

NEXEDGE Multi Digital & FM Mobile Radio
NX-5700/5800



Display	Color 2.55" (154 x 422 pixels) TFT LCD	
Frequency range	VHF	136-174 MHz (NX-5700)
	UHF	400-470 MHz (NX-5800)
RF output	VHF	50-5 W (NX-5700)
	UHF	45-5 W (NX-5800)
CH-GID/Zones	Max. of 4,000 CH-GID 512/128	
Common air interface	NXDN, DMR, P25 (Phase I & II), & FM	
Vocoder	AMBE+2™	
Signaling modes	Fleetsync, MDC-1200, QT/DQT, DTMF	
NXDN digital trunking	Gen2 & Type-C	
P25	Phase I & II	
GPS	Built-in (Requires optional GPS Active Antenna KRA-40G)	
IP code	IP54/IP55	

Base-Repeaters

Built tough for 24/7 reliability and fully supporting mixed FM/digital operation, the slim form factor of NEXEDGE repeaters save space.

NEXEDGE Digital & FM Base-Repeater
NXR-5700/5800



NEXEDGE Digital & FM Base-Repeater
NXR-710/810



Frequency range	VHF	136-174 MHz (NXR-5700)	136-174 MHz (NXR-710)
	UHF	Type 1: 450-520 MHz, Type 2: 400-470 MHz, Type 3: 350-400 MHz (NXR-5800)	400-470 MHz (NXR-810)
RF output	VHF	25/5/0.5 W (NXR-5700)	50 W @50% duty, 25 W @100% duty (NXR-710)
	UHF	25/5/0.5 W (NXR-5800)	40 W @50% duty, 25 W @100% duty (NXR-810)
IP interface for sending remote control command	Built-in (in conventional and trunking modes)		Optional (in conventional mode)
Common air interface	NXDN & FM		NXDN & FM
Vocoder	AMBE+2™		AMBE+2™
Multi-operation	Multi-Digital and FM analog on the same channel		NXDN digital conventional, FM analog on the same channel
Scanning (conventional mode)	30 channels in conventional mode		30 channels in conventional mode
NXDN digital trunking	Gen2 & Type-C		Type-D
P25	Phase I & II		—

NEXEDGE Digital & FM Mobile Radio
NX-700/800



NEXEDGE Digital & FM Mobile Radio
NX-720(G)/820(G)



14-character alphanumeric aliases & backlit dot matrix LCD	13-segment & backlit 8-digit LCD
136-174 MHz (NX-700)	136-174 MHz (NX-720(G))
400-470 MHz (NX-800)	400-470 MHz (NX-820(G))
25-1 W (NX-700)	25-5 W (NX-720(G))
25-1 W (NX-800)	25-5 W (NX-820(G))
512/128	260/120
NXDN & FM	NXDN & FM
AMBE+2™	AMBE+2™
Fleetsync, MDC-1200, QT/DQT, DTMF, 5-Tone, MPT	Fleetsync, MDC-1200, QT/DQT, DTMF, 5-Tone, MPT
Gen2 & Type-C	Gen2 & Type-C & Type-D
—	—
Optionally available	Built-in for models with suffix G (Requires optional GPS Active Antenna KRA-40G)
IP54/IP55	IP54/IP55

Multiple Configurations

The NX-5700/NX-5800 mobile radios allow users to create a variety of configurations to suit diverse requirements by combining different options.

- 1. Single Remote Control Head x Single RF Deck** The detachable front control panel of the radio is used as a Remote Control Head.
- 2. Single Remote Control Head x Multi RF Decks** Operate multiple radios as if they were one by adding an RF Deck.
- 3. Dual Remote Control Heads x Single RF Decks** One controller can be mounted on the dashboard, with the other at the rear.
- 4. Dual Remote Control Heads x Multi RF Decks** The convenience of a dual control head added to multiple RF decks (3 maximum) configuration. Two operators can control 2 radios from separate control heads.



Base-repeater Optional Units



KTI-3
Network Interface Unit



KTI-4
Telephone Interconnect Adapter



KTI-5
Multipurpose Network / Interface Box

IP Network Connector for the NXR-710/810 Series – KTI-3

The Conventional IP Network feature is available for NXR-710/810 repeaters with the Network Interface Unit KTI-3.











Telephone Interface Adapter for the NXR-5700/5800 Series – KTI-4

The KTI-4 Telephone Interconnect Adapter adds telephone system connectivity to the NXR-5700/5800 based trunking system with an analogue telephone patch. It is ideal for customers with intentions to enhance the flexibility of their networks by connecting their trunking system to a telephone line.

Multipurpose Network / Interface Box for the NXR-710/810 Series – KTI-5*

*KTI-5 is a hardware / device only, requires appropriate firmware.

Configurations for NEXEDGE Systems

Conventional	Conventional IP Network	NXDN Type-D Trunking	NXDN Type-C Trunking	NXDN Type-C Trunking Generation 2
				
				
(No trunking)	(No trunking)	Decentralised control trunking	Centralised control trunking	Centralised control trunking server-based architecture
Single site	Up to 16 sites (unicast) Up to 48 sites (multicast)	Single site	Up to 48 sites	Up to 1000 sites
Cost & capacity baseline	Cost effective coverage	Cost effective capacity	Capacity and coverage	Capacity, coverage and control

Specifications are subject to change without notice, due to advancements in technology.

AMBE+2™ is a trademark of Digital Voice Systems Inc.

Microsoft®, Windows®, MapPoint®, Visual Studio®, Visual C#®, and .NET Framework® are registered trademarks of Microsoft Corporation in the United States and other countries.

Apple, iPad, iPhone, and iTunes are trademarks of Apple Inc. registered in the U.S. and other countries.

App Store is a service mark of Apple Inc.

Google Earth™ is a trademark of Google Inc.

Wi-Fi® is a registered trademark of Wi-Fi Alliance.

UNIX is a registered trademark of The Open Group in the United States and other countries.

Icom, Icom Inc. and the IDAS are registered trademarks of Icom Incorporated.

NXDN™ is a trademark of JVCKENWOOD Corporation and Icom Inc.

NEXEDGE® is a registered trademark of JVCKENWOOD Corporation.

Note: Downloading, installation or using Google Earth software or using service is subject to Google Inc. Terms of Service, Legal Notices and Additional Terms.

KENWOOD

JVCKENWOOD U.K. Ltd

12 Priestley Way, London, NW2 7BA, United Kingdom

<http://kenwoodcommunications.co.uk>

